



Test of Variables of Attention®

Synchronization Interface v3

User's and Technical Manual

800.729.2886 (562.594.7700)
info@tovatest.com
<http://www.tovatest.com/>

Synchronization Interface v3

Andrew Greenberg, MS

The TOVA Company

222 Anthes Ave Ste 101
Langley, WA 98260 USA

Phone: 800.PAY.ATTN or 800.729.2886 or 562.594.7700
Fax: 800.452.6919 or 562.594.7770
Email: info@tovatest.com
Web: <http://www.tovatest.com/>

© Copyright 2013-2020 The TOVA Company, All Rights Reserved.

Test Of Variables of Attention (abbreviated T.O.V.A.) is a registered trademark of The TOVA Company.

No part of this manual may be distributed without permission of The TOVA Company.

Orders of this manual should be directed to:

The TOVA Company
222 Anthes Ave Ste 101
Langley, WA 98260 USA
800.PAY.ATTN 800.729.2886 +1.562.594.7700
Fax 800.452.6919 +1.562.594.7770

Printed in the United States of America.

Contents

Important Information	1
Introduction	1
System Requirements	1
Understanding T.O.V.A. timing	2
Setup and Testing	3
Setting up and configuring your T.O.V.A. sync interface	3
Testing your sync interface	4
Output Modes: Active High or Passive High	4
Active high output mode	5
Passive output mode	5
Output Signals	5
Technical Details	6

Important Information

The Test of Variables of Attention (T.O.V.A.) synchronization interface has not been cleared as a medical device and is for research use only. Please contact The TOVA Company for more information.

Introduction

The T.O.V.A. Synchronization Interface, or “sync interface”, is an add-on to the standard T.O.V.A. system that allows researchers to synchronize events in the T.O.V.A. test with other laboratory equipment. The sync interface gets event messages from the T.O.V.A. USB device and transmits the events as electrically isolated digital signals. The user’s laboratory equipment (e.g., EEG equipment) then records the sync interface’s outputs on 1 to 4 auxiliary input channels. By recording T.O.V.A. events in the data stream of the user’s laboratory equipment, the two data streams can now be precisely correlated in time.

Note: the sync interface does *not* record data; it is an output-only device.

An example use case of the sync device is to measure evoked potentials. A researcher would connect the T.O.V.A. sync interface’s outputs to spare analog channels (or auxiliary digital inputs) of their EEG system. They would administer a T.O.V.A. (audio or visual) session as usual, with the subject wearing EEG leads, and collect EEG data as the T.O.V.A. is being administered. The sync interface sends the T.O.V.A. test and response information (stimulus onset, target or nontarget indicator, and button presses) as digital outputs which are recorded by the EEG equipment along with EEG waveforms. Offline, the researcher can now investigate time synchronized EEG responses to the T.O.V.A. stimuli, as well as subject responses (button presses).



Figure 1: The T.O.V.A. Synchronization Interface

System Requirements

- A fully working T.O.V.A. 8 or 9 installation on a Windows, Macintosh, or Linux PC. For T.O.V.A. system requirements, please see the T.O.V.A. User’s Manual or the T.O.V.A. website at <http://www.tovatest.com/>.

- A synchronization-enabled T.O.V.A. USB device (see Figure 2). Synchronization-enabled USB devices have two 'microswitch ports' on their front face panel, instead of the usual one. The sync-enabled USB device should be provided as part of the sync interface kit.
- Data acquisition equipment with 1 - 4 digital inputs that can record a digital high level of approximately 5.0 V.



Figure 2: T.O.V.A. USB device with extra front panel connector)

Understanding T.O.V.A. timing

The Adult and Youth T.O.V.A. test is 21.6 minutes long and has 648 stimuli displayed every 2 seconds. The Preschool test is only 10.8 minutes long and has 324 stimuli played every 2 seconds. Each stimuli can be a visual or auditory stimuli: see the T.O.V.A. User's Manual for a description of the T.O.V.A. stimuli. Each stimuli can be a target (the subject should press the button as quickly as possible) or a nontarget (the subject should not press the button).

Each stimuli is presented in an "Inter-Stimulus Interval" or ISI that is 2 seconds (2,000 milliseconds) long (see Figure 3). There are three main sections to each ISI:

- 100 ms waiting period before each stimulus display to catch anticipatory responses.
- 100 ms stimulus on period, in which each stimuli is displayed (on screen for visual stimuli, or played on the speakers for auditory stimuli)
- 1,800 ms waiting period for the subject to respond (or not respond).

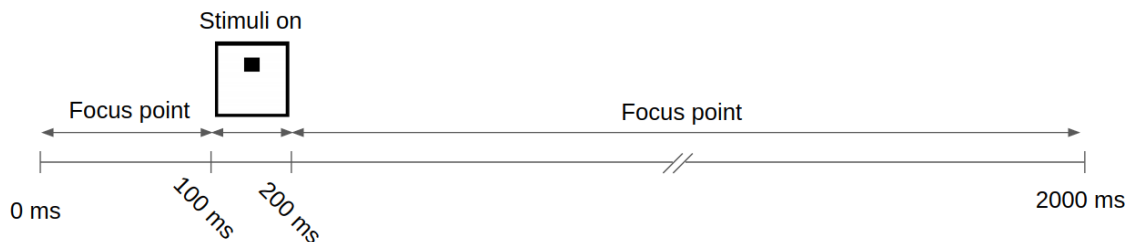

Figure 3: Inter-Stimulus Interval (ISI) timeline

Note, however, that the subject's response time is calculated from the start of the stimulus on time of 100 ms into the ISI (see Figure 4) and continues to the ISI end, for a maximum response time value of 1,800 ms. The subject's response is broken into two sections:

- From the beginning of the ISI at -100 ms (with respect to the "0" of the stimulus start) to 150 ms after the stimulus start is considered an anticipatory response. For a Go/No-Go task, there is no way for a subject response faster than 150 ms and thus any response in this time window is a "guess" response.
- From 150 ms to the end of the ISI at 1,800 ms is the response time window, again calculated from the start of the stimulus.

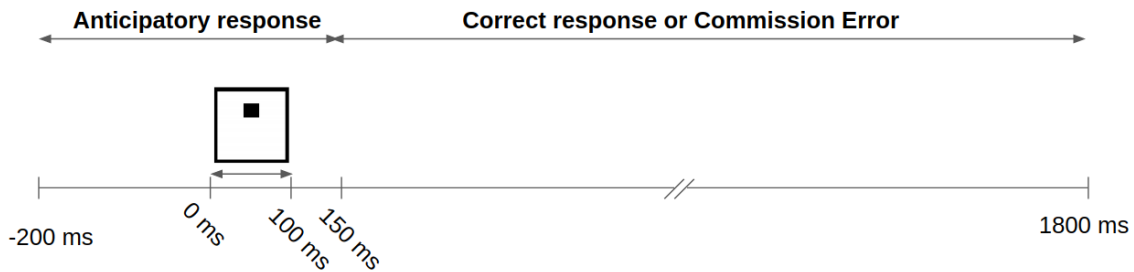

Figure 4: Timeline for the subject response time calculations

Setup and Testing

WARNING: The sync interface will automatically output events during the practice test and T.O.V.A. test. Please configure your sync interface BEFORE connecting it to your lab equipment.

Setting up and configuring your T.O.V.A. sync interface

1. If not installed already, install the T.O.V.A. system according to the T.O.V.A. Installation Guide (or User's Manual) and verify its operation.
2. Plug the T.O.V.A. sync interface into an open connector on the front panel of the T.O.V.A. USB device. Both front panel connectors are equivalent, so either connector will work.
3. Run the T.O.V.A.
4. The light on the top of the sync interface should light up yellow.
5. Choose '**Preferences**' on the main window.
6. In the Preferences dialog, choose '**Sync Interface**'.
7. In the Sync interface preferences (see Figure 5), choose either "Active high output" or "Passive high output".
 - (a) "Active high output" will output an active 5 V "high" signal and active 0 V "low" signal on the outputs of the sync interface.

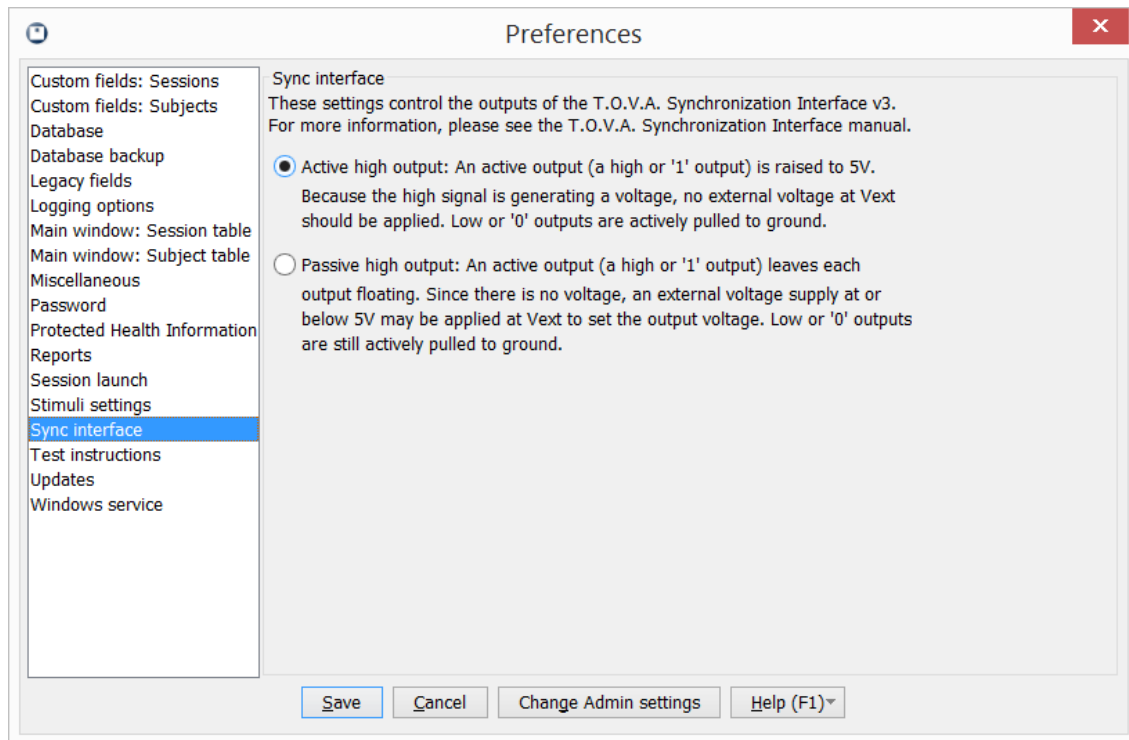

Figure 5: Configuring the Sync Interface preferences in the Preferences dialog

- (b) “Passive high output” will only output an an active 0 V “low” signal, and passively leave the “high” signals floating. This allows you to provide your own voltage level at the V-EXT input to the sync device (or in your own equipment).
- (c) Please see the **Output Modes** section (page 4) for more information.

8. The sync interface is now configured.

Testing your sync interface

1. Choose ‘**Help**’ on the main window, ‘**Check T.O.V.A. Hardware**’, ‘**Sync Control**’.
2. Verify your output mode is correct in the dialog.
3. Click on any of the four output checkboxes to activate the outputs of the sync interface (see Figure 6). You should be able to confirm with your equipment (or a volt meter) that each output turns on and off by clicking the checkboxes.

Output Modes: Active High or Passive High

The sync interface can be set in one of two output modes: Active or Passive output modes. To change output modes, see the **Setup and Testing** section above (page 4).

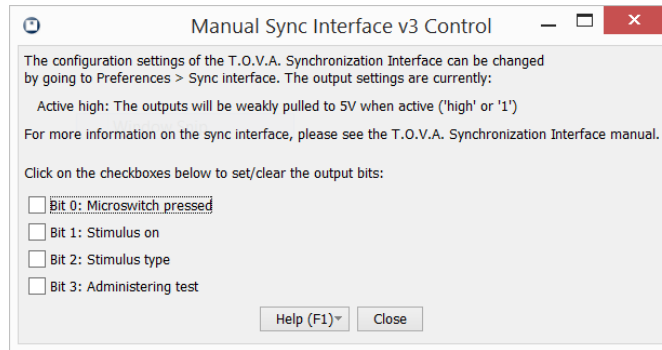

Figure 6: Testing the Sync Interface using the Manual Control dialog

Active high output mode

In active high output mode, when a signal is asserted, a roughly 5 V signal is asserted on the sync interface output. The output is very high impedance (around several $k\Omega$) and thus will not harm most digital equipment and can be safely accidentally shorted to ground.

When a signal is deasserted, the sync interface output is connected through a low impedance ($50\ \Omega$) path to 0 V ground. Because of this low impedance output, do not connect a supply voltage directly to the outputs without an intervening pull-up resistor of around $1\ k\Omega$ or more.

Passive output mode

In passive output mode, when a signal is asserted, the sync interface will not provide any voltage on the sync interface output at all. Instead, the signal will “float” with a very high impedance (100s of $M\Omega$). This “floating high”, or “passive high” output state is useful when you need to provide your own voltage signal to your equipment. The **V-EXT** connector on the sync interface allows you to provide this external voltage. Note that this diode is connected to the output lines through a diode and a $10\ k\Omega$ pull-up resistor, so a power supply up to 5 V may directly connected to the V-EXT connector.

For example: to provide a 1.0 V signals into your equipment, you would choose passive output mode, and provide a 1.3 V voltage supply to the V-EXT input connector on the sync interface. All asserted signals would then provide a 1.0 V signal (1.3 V minus 0.3 V of the Schottky diode in the sync interface becomes 1.0 V).

When a signal is deasserted, the sync interface output is connected through a low impedance ($50\ \Omega$) path to 0 V ground. Because of this low impedance output, do not connect a supply voltage directly to the outputs without an intervening pull-up resistor of around $1\ k\Omega$ or more.

Output Signals

Table 1 describes the four output signals (“bits”) on the sync interface. Figure 7 shows an example of how these bits correlate to various T.O.V.A. test events.

Bit Number	Label	Description
B0	'SWITCH'	Microswitch pressed: this bit is high (1) when the microswitch is being pressed, and low (0) when the microswitch has been released.
B1	'STIM ON'	Stimulus display on: this bit is high (1) when the stimulus is displayed. This means either the visual stimulus displayed on the monitor or the auditory stimulus being played on the speakers. This bit is low (0) when the stimulus is not being displayed.
B2	'TARGET'	Target/Nontarget: this bit is high (1) when the stimulus being displayed is a target, and low (0) when the stimulus being displayed is a nontarget. Note that this signal is only asserted when 'stimulus on' is high.
B3	'TEST'	Administering test: this bit is high (1) when the test is being administered. It is low (0) before and after the test, as well as during a pause due to some user interrupt or hardware error.

Table 1: Sync interface output signals (“bits”)

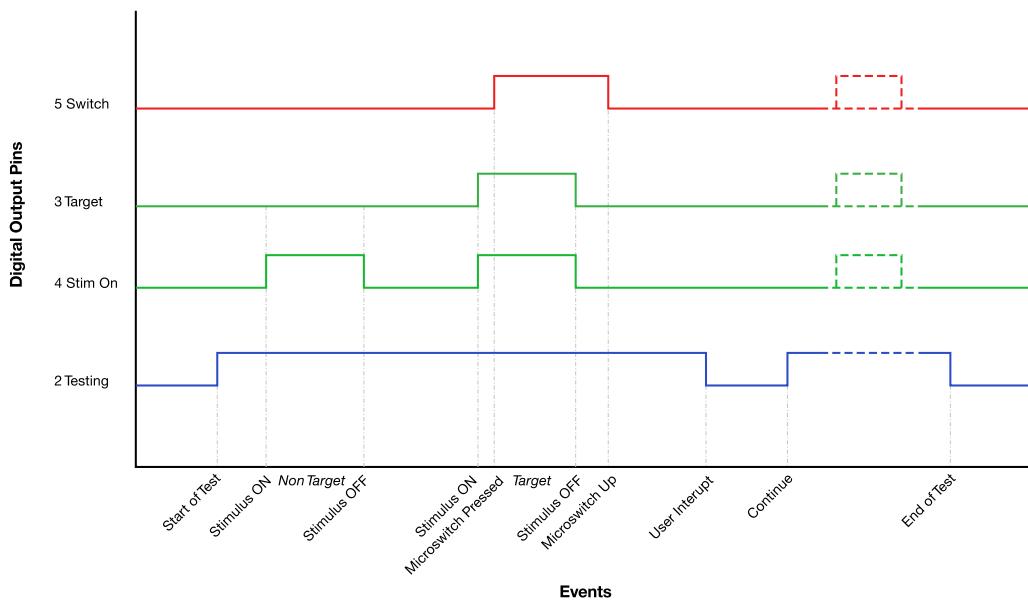

Figure 7: Timing diagram of sync interface outputs and T.O.V.A. events

Technical Details

A schematic of the sync interface's outputs and V-EXT input are provided in Figure 8. Don't hesitate to contact us if you have any technical questions about this schematic or how to attach the sync interface to your equipment.

All outputs are optically isolated. There are two different opto-isolators used in the sync interface:

1. The active output high uses a Toshiba TLP191B, a "Photocoupler IRED & Photo-Diode Array". The TLP191B consists of an infrared emitting diode, optically coupled to a series connected photo diode array with shunt resistor. Exactly like a solar cell, this photodiode array generates an opto-isolated 5V signal that can be used to make an actively high (voltage generating) output.
2. The low output uses a On Semiconductor H11F1SM "photo FET optocoupler" to pull the outputs to ground.

Other technical details:

1. The connectors are standard BNC connectors, with a grounded outer shell, and the signal on the center pin.
2. Timing should be on the order of several hundred microseconds from the exact time of the signal.

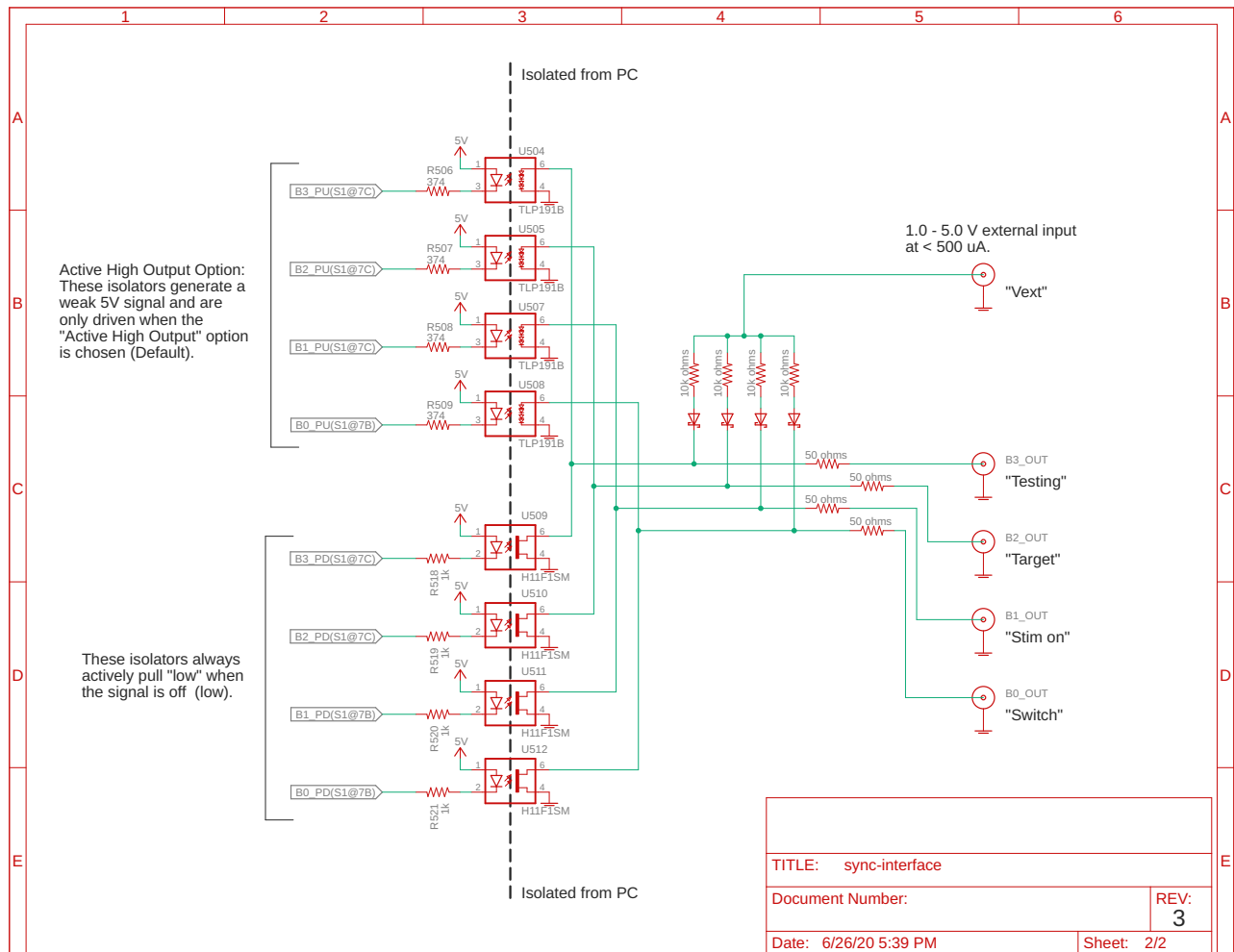

Figure 8: Schematic of the sync interface's isolated outputs and input